



Airflex® Type DC Element Description



Type DC elements can be used as either pressure actuated clutches or brakes. They are available in single and multiple disc designs.

Element construction and operation is illustrated in the figure. Pressurizing the cylinder causes the piston to clamp the friction disc assemblies between clamping plates. External springs ensure positive disengagement.

Type DC elements are available in five basic disc sizes with static torque ratings to 2,061,000 lb-in (233,000 N·m). Element sizes are indicated by the number of friction discs and by the disc diameter in inches. For instance, size 225DC has two friction discs 25 inches in diameter.



Features

Favorable torque to size ratio.

DC type elements are physically smaller than most other type clutches and brakes with the same torque capacity.

Low inertia friction disc assembly.

Reduces the overall inertia that must be started or stopped.

Optional split friction discs.

Allows removal of friction discs without disturbing other components of drive system in mid-shaft element arrangement.

Long wearing, self lubricating PolyPak* seals.

Eliminates premature twisting failure and requires no external lubrication.

Where used:

- Power Presses
- Tension Brakes
- Emergency Stop Brakes on Unwind Stands



Airflex® DC Component Parts

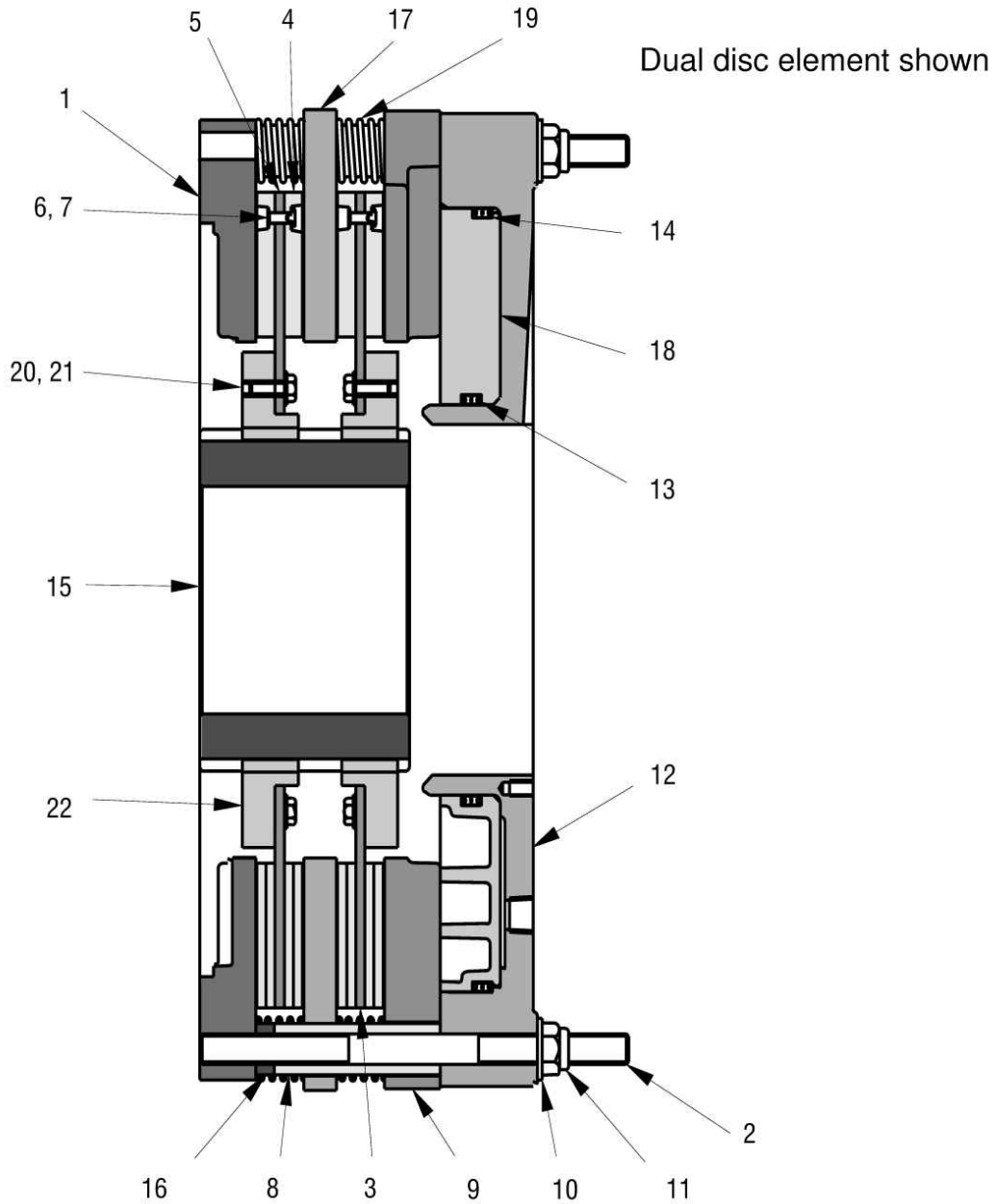

Item Number	Description
1	Mounting Flange
2	Stud
3	Friction Disc Sub-Assembly
4	Friction Disc
5	Friction Disc Core
6	Rivet
7	Washer
8	Clamp Tube
9	Pressure Plate
10	Flat Washer
11	Locknut

Item Number	Description
12	Cylinder
13	Inner Seal
14	Outer Seal
15	Gear
16	Wear Spacer
17	Reaction Plate
18	Piston
19	Release Spring
20	Flat Washer
21	Hex Head Screw
22	Ring Gear



Airflex® Type DC Elements



Technical Data

English	lb·in @ 75 psi	rpm	in ³		in ²	lb·ft ²		lb		
109DC	10500	3000	1600	4	24	96	8	0.5	60	9
209DC	21000	3000	1600	7	30	192	9.5	1	70	18
115DC	41000	2400	1050	9	60	238	55	5	170	35
215DC	82000	2400	1050	17	70	476	65	10	190	64
120DC	77000	1850	850	27	133	334	82	17	235	77
220DC	154000	1850	850	53	160	668	104	33	297	145
320DC	231000	1850	850	79	187	1002	126	49	359	213
420DC	308000	1850	850	105	214	1336	148	66	421	281
125DC	160000	1400	650	43	216	600	339	47	557	143
225DC	320000	1400	650	86	259	1201	420	93	689	273
325DC	480000	1400	650	129	302	1801	501	140	821	403
425DC	640000	1400	650	172	345	2400	582	186	953	533
138DC	560000	950	450	102	510	1322	2031	287	1568	413
238DC	1120000	950	450	203	612	2644	2139	562	1651	750
338DC	1680000	950	450	304	714	3966	2247	837	1734	1087
438DC	2240000	950	450	405	816	5288	2355	1112	1817	1424

Size	M, Torque Rating	Disc Element		New Worn		Friction Area	Wk ²		Weight	
		Maximum Speed		Engaging Volume			Housing	Disc & Gear ⁶	Housing	Disc & Gear ⁶
		Disc	Element	New	Worn					
109DC	1190	3000	1600	0,07	0,39	619	0,34	0,02	27	4
209DC	2370	3000	1600	0,11	0,49	1238	0,40	0,04	32	8
115DC	4630	2400	1050	0,15	0,99	1535	2,32	0,21	77	16
215DC	9260	2400	1050	0,28	1,15	3069	2,74	0,42	86	29
120DC	8690	1850	850	0,44	2,18	2154	3,46	0,72	107	35
220DC	17390	1850	850	0,87	2,63	4307	4,38	1,39	135	66
320DC	26080	1850	850	1,30	3,07	6461	5,31	2,06	163	97
420DC	34770	1850	850	1,72	3,52	8614	6,24	2,76	191	127
125DC	18060	1400	650	0,71	3,55	3869	14,29	1,98	253	65
225DC	36130	1400	650	1,41	4,25	7744	17,70	3,92	312	124
325DC	54190	1400	650	2,12	4,96	11619	21,11	5,90	372	183
425DC	72260	1400	650	2,83	5,67	15488	24,53	7,84	432	242
138DC	63220	950	450	1,68	8,38	8524	85,59	12,09	711	187
238DC	126450	950	450	3,33	10,05	17048	90,14	23,68	749	340
338DC	189670	950	450	4,99	11,73	25572	94,69	35,27	786	493
438DC	252900	950	450	6,65	13,41	34097	99,24	46,86	824	646

SI	N·m @ 5,2 bar	rpm	dm ³	cm ²	kg·m ²	kg
----	------------------	-----	-----------------	-----------------	-------------------	----

Mounting Bolt Circles

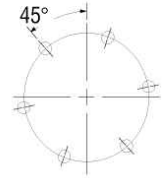

9DC
(6) 0.531 (13.5) Ø Mounting Holes Equally Spaced as Shown on 11.125 (282.5) Bolt Circle

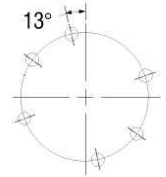

15DC
(8) 0.656 (16.7) Ø Mounting Holes Based on 8 Equally Spaced as Shown on 17.500 (444.5) Bolt Circle

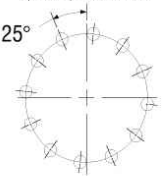

20DC
(12) 0.656 (16.7) Ø Mounting Holes Equally Spaced as Shown on 22.000 (558.8) Bolt Circle

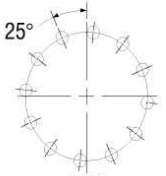

25DC
(12) 0.656 (16.7) Ø Mounting Holes Equally Spaced as Shown on 28.750 (730.3) Bolt Circle

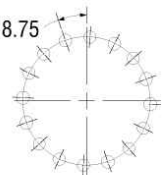

38DBC
(16) 1.062 (27.0) Ø Mounting Holes Equally Spaced as Shown on 42.000 (1066.8) Bolt Circle

- Notes:**
- ① Dynamic torque shown. Static torque 15% greater. Maximum allowable pressure 120 psi (8,3 bar).
 - ② Absolute cylinder volume with new or worn friction linings.
 - ③ Based upon minimum bore.
 - ④ Basic part number only. Gear not included.
 - ⑤ Tolerance +0.000/-0.003 in (+0,00/-0,08 mm)
 - ⑥ Tolerance +0.003/-0.000 in (+0,08/-0,00 mm)
 - ⑦ Maximum diameter of "as cast" surfaces.
 - ⑧ American National Pipe Thread
 - ⑨ Some high torque applications of three and four disc elements require additional support on the cylinder side of the unit. Contact your local Airflex representative for more details.
 - ◆ (12) 0.781 (19,8) Diameter mounting holes equally spaced as shown on 28.750 (730,3) bolt circle
 - See note 4 on revised page E-3
 - * See note 5 on revised page E-3



Airflex® Type DC Elements

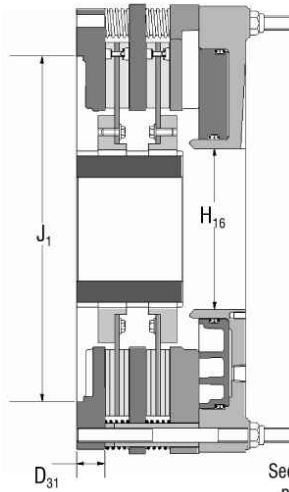
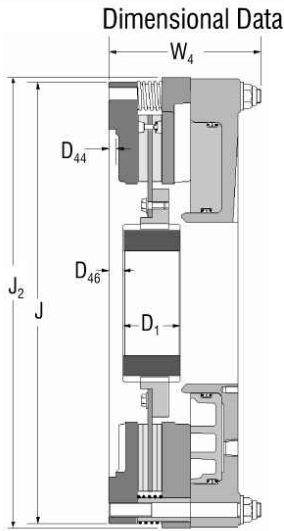

See Note on ⑤
pg. E-14

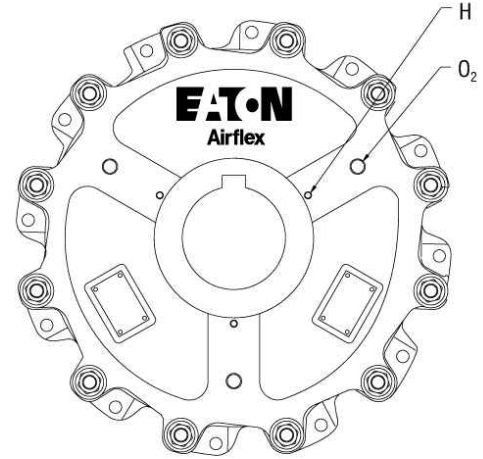

English		Dimensions in inches					
109DC	146239	415313	1.75	2.38	1.75	5.63	0.25
209DC	146240	415510	1.88	2.38	3.25	7.63	0.25
115DC	146225	415454	2.75	3.98	2.88	7.00	0.38
215DC	146226	415454	3.44	3.94	4.38	9.00	0.38
120DC	146301	415900	3.31	5.63	3.00	8.00	0.75
220DC	146317	415959	4.25	5.69	5.63	11.50	0.00
320DC	146366	416304	4.88	5.56	8.25	14.63	0.00
420DC	146390	416472	5.44	5.69	12.50	16.25	0.00
125DC	146316	416073	4.38	7.13	3.50	9.50	0.75
225DC	146355	416074	5.50	7.13	7.00	12.00	0.38
325DC	146354	416223	6.25	6.88	9.31	14.50	0.00
425DC	146389	416477	6.25	6.88	12.00	18.00	0.00
138DC	146307	416068	6.75	10.50	5.00	13.50	1.25
238DC	146336	416069	8.50	10.25	9.00	16.50	0.00
338DC	146360	416241	9.25	9.75	13.00	19.50	0.00
438DC	416388	416461	8.50	10.25	18.00	25.00	0.00
Size	Part Number	Gear Part Number	Min. Bore Range	Max. Bore Range	D ₁	W ₄	D ₄₆

SI		Dimensions in millimeters					
109DC	146239	415313	44	60	44	143	6
209DC	146240	415510	48	60	83	194	6
115DC	146225	415454	70	98	73	178	10
215DC	146226	415454	87	100	111	229	10
120DC	146301	415900	97	143	76	203	19
220DC	146317	415901	108	143	143	292	0
320DC	146366	416304	124	141	210	372	0
420DC	146390	416374	138	145	318	413	0
125DC	146316	416073	111	181	89	241	19
225DC	146355	416074	140	181	178	305	10
325DC	146354	416623	159	175	236	368	0
425DC	146389	416477	159	175	305	457	0
138DC	146307	416068	171	267	127	343	32
238DC	146336	416069	216	260	229	419	0
338DC	146360	416241	235	248	330	495	0
438DC	146388	416461	216	260	457	635	0
Size	Part Number	Gear Part Number	Min. Bore Range	Max. Bore Range	D ₁	W ₄	D ₄₆

English		Dimensions in inches								
9DC	1.00	0.25	3.25	3	1/4-20NC-2	3.50	12.125	8.375	12.37	3/8-14
15DC	1.47	0.38	6.00	3	3/8-16NC-2	6.50	18.375	14.375	18.94	1/2-14
20DC	1.50	0.38	8.50	3	3/8-16NC-2	9.13	23.250	18.250	23.82	1/2-14
25DC	1.75	0.25	11.50	4	3/8-16NC-2	12.25	30.630	24.375	30.58	1/2-14
38DC	2.45	0.25	16.50	4	1/2-13NC-2	17.50	44.750	36.375	44.86	3/4-14
Size	D ₃₁	D ₄₄	H ₁₆	No. Size Bolt Circle			⑤ J	⑥ J ₁	⑦ J ₂	⑧ O ₂
				H	H	H				
Size	D ₃₁	D ₄₄	H ₁₆	No. Size Bolt Circle			⑤ J	⑥ J ₁	⑦ J ₂	⑧ O ₂
				H	H	H				
9DC	25	6	83	3	1/4-20NC-2	89	308,0	212,7	314	3/8-14
15DC	37	10	152	3	3/8-16NC-2	165	466,7	365,1	481	1/2-14
20DC	38	10	216	3	3/8-16NC-2	232	590,6	463,5	605	1/2-14
25DC	44	6	292	4	3/8-16NC-2	311	778,0	619,1	777	1/2-14
38DC	62	6	419	4	1/2-13NC-2	445	1136,7	923,9	1139	3/4-14
SI		Dimensions in millimeters								

Notes are on page E - 14